



PN 25 DUCTILE IRON GLOBE VALVE

Outside Screw & Yoke

STANDARDS	
DESIGN STANDARD	BS EN 558-1 (1)
END CONNECTION	BS EN 1092-2 PN 25 / DIN 2501 / BS 4504
END TO END	DIN 3202(1) / BS 5152 / DIN 3352 / EN 13789
TESTING STANDARD	API 598

Applications: Regulation & Control of Oil and Gas, Hot and Cold Water, Fluids, Air, Steam, Raw and Sea Water

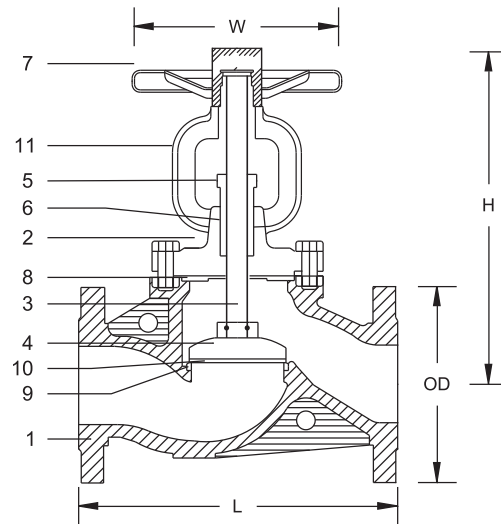

COMPONENT	SPECIFICATIONS
1	BODY DUCTILE IRON (EN-GJS-400) / GGG40
2	BONNET DUCTILE IRON (EN-GJS-400) / GGG40
3	STEM STAINLESS STEEL 420 / EN 1.4021
4	DISC For < 2" STAINLESS STEEL 420 / EN 1.4021 For > 2" DUCTILE IRON (EN-GJS-400) / GGG40
5	GLAND DUCTILE IRON (EN-GJS-400) / GGG40
6	GLAND PACKING FLEXIBLE GRAPHITE
7	HAND WHEEL DUCTILE IRON (EN-GJS-400) / GGG40
8	GASKET NON ASBESTOS SHEET
9	BODY SEAT RING STAINLESS STEEL 420 / EN 1.4021
10	DISC SEAT RING STAINLESS STEEL 420 / EN 1.4021
11	YOKE DUCTILE IRON (EN-GJS-400) / GGG40

Dimensions in mm

DN	15	20	25	32	40	50	65	80	100	125	150	200	250	300
L	130	150	160	180	200	230	290	310	350	400	480	600	730	850
OD	95	105	115	140	150	165	180	200	235	270	300	360	425	485
H	205	205	217	217	243	243	263	287	383	416	450	622	763	890
W	102	102	130	130	145	145	205	205	230	230	290	380	490	490